

PANEL PREPARATION

ASSEMBLY	PAWL	GRIP RANGE	
		LETTER	MIN MAX
24-20-101-35	62-18-301-17	A	.45 1.37
24-20-102-35	62-18-302-17	B	.95 1.86
24-20-104-35	62-18-301-17	C	1.45 2.32

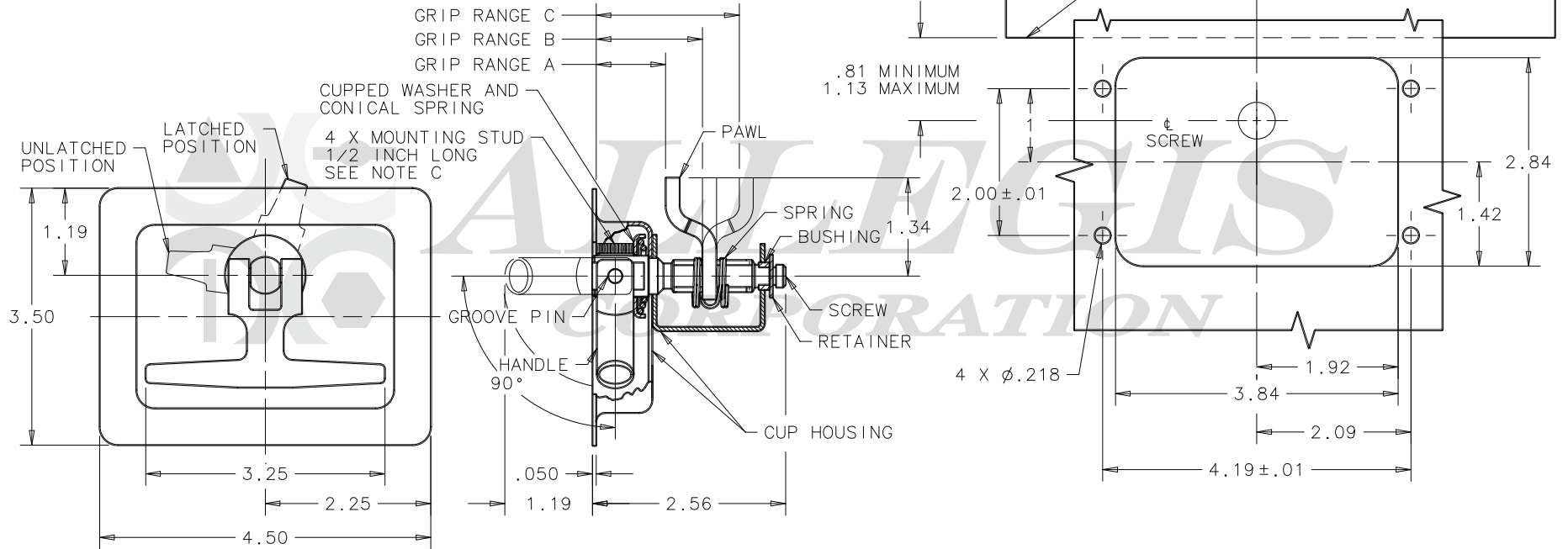

www.ALLEGISCORP.com 1-866-378-7550		MATERIAL / FINISH : Stainless Steel	
REV. : 1 : 1	DATE : 5-1-2018	DESCRIPTION : T-Handle	DRAWING NO. : 24-20-104-35